

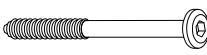





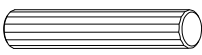

Gabriel

1548_135103

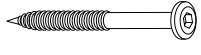
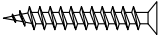
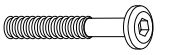

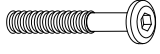
1548_135103

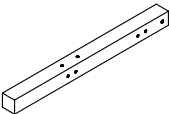
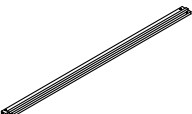
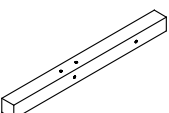
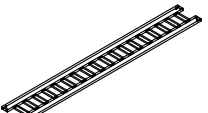
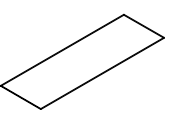
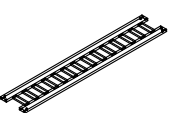
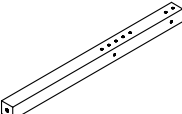
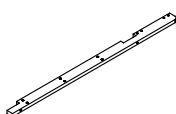
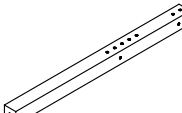
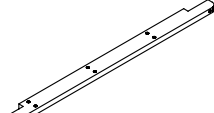
A		M6*90MM	X38PC	1 / 2	F		Φ8*20MM	X4PC	1 / 2
B			X40PC	1 / 2	G		Φ12*60MM	X4PC	1 / 2
C		Φ8*30MM	X30PC	1 / 2	H			X2PC	1 / 2
D		Φ6*70MM	X12PC	1 / 2	I		Φ4*30MM	X68PC	1 / 2
E		M6*50MM	X4PC	1 / 2	J			X14PC	1 / 2
					K		M6*60MM	X2PC	1 / 2

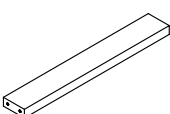
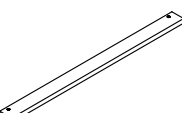
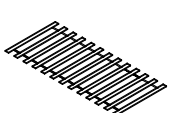
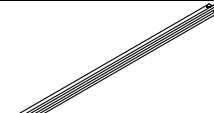
1		635*50*50	X2PC	1 / 2	9		1870*90*20	X2PC	1 / 2
2		635*50*50	X2PC	1 / 2	10		1870*252*18	X1PC	1 / 2
3		871*238*5	X4PC	1 / 2	11		1446*252*18	X1PC	1 / 2
4		765*50*50	X2PC	1 / 2	12		1192*60*20	X1PC	1 / 2
5		765*50*50	X2PC	1 / 2	13		930*60*20	X1PC	1 / 2
6		870*90*20	X4PC	1 / 2	14		380*55*20	X3PC	1 / 2
7		870*60*20	X4PC	1 / 2	15		899*60*13	X30PC	2 / 2
8		1870*90*20	X2PC	1 / 2					

FR : SAV/INFORMATION /VIDEO/CONTACT

EN: AFTER-SALES SERVICE/INFORMATION/VIDEO/CONTACT

DE : REPARATUR-SERVICE UND ERSATZTEILE /INFORMATIONEN /VIDEO/KONTAKT

ES: SERVICIO POST-VENTA/INFORMACION/VIDEO/CONTACTO

IT: SERVIZIO ASSISTENZA/INFORMAZIONI/VIDEO/CONTATTO

PT: SERVIÇO PÓS-VENDA/INFORMAÇÕES/VIDEO/CONTATO

PL: SERWIS TECHNICZNY/INFORMACJE/WIDEO/KONTAKT

NE: AFTER SALES SERVICE/INFORMATIE/VIDEO/CONTACT

HE: מע רשקתל/ואדיוור / עדימ/תורכמו תוריש רחאל

SAV.HABITATETJARDIN.COM

2/10

2022-2023

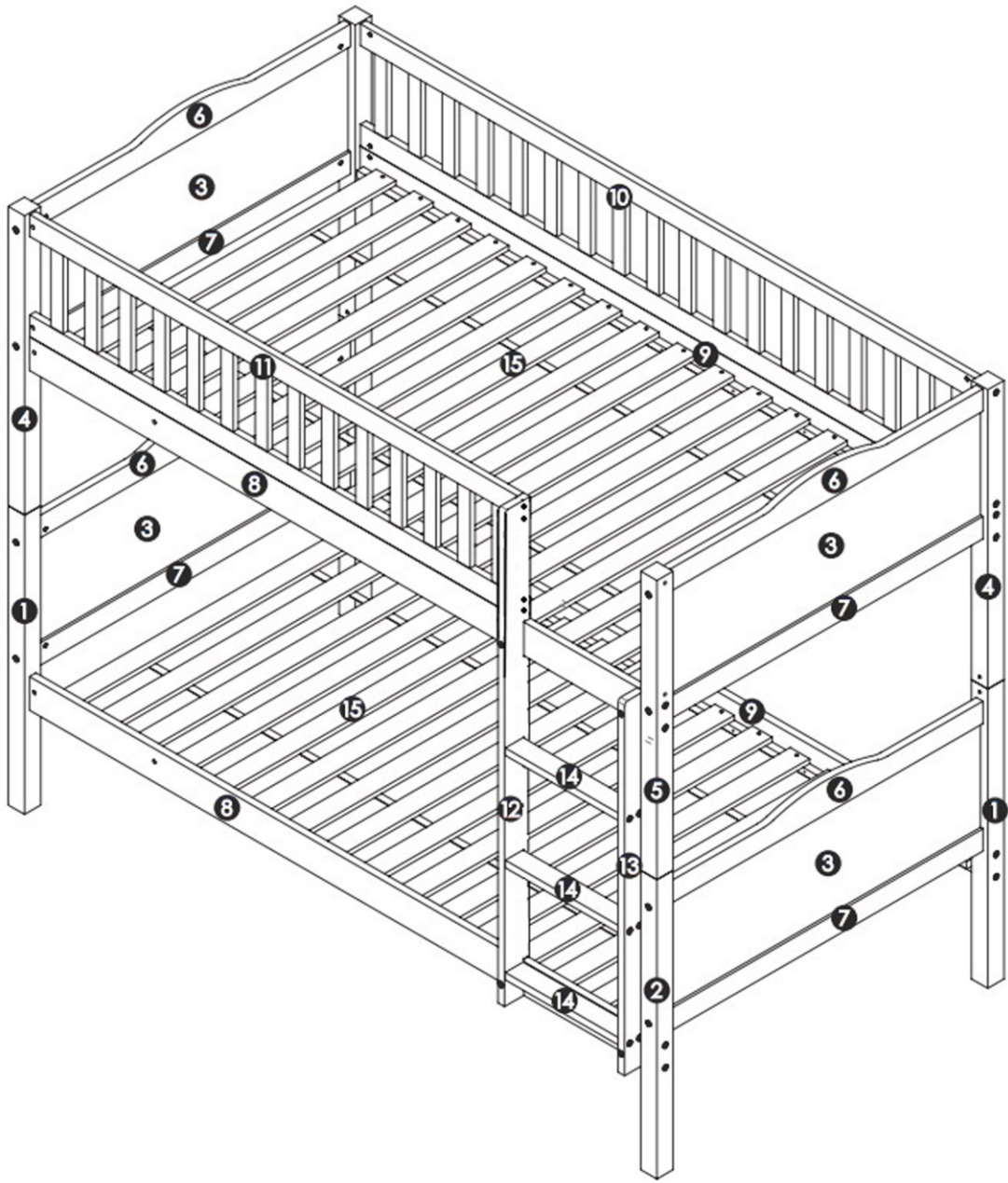

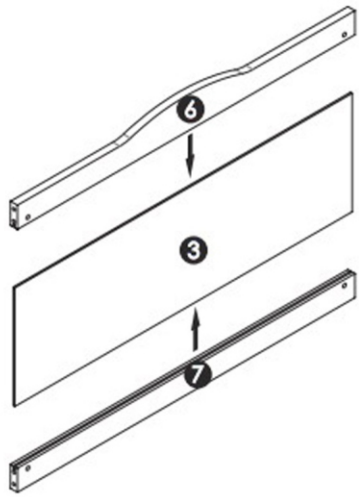

step1 (x4)



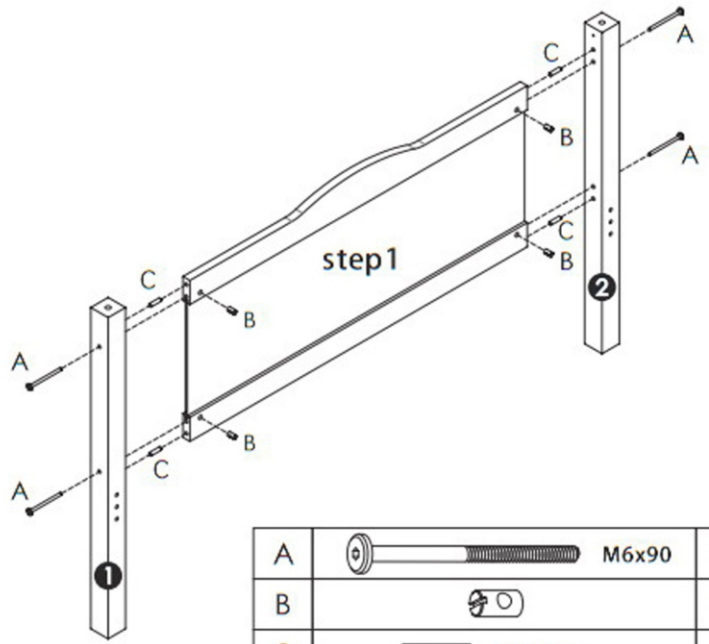



step2 (x2)

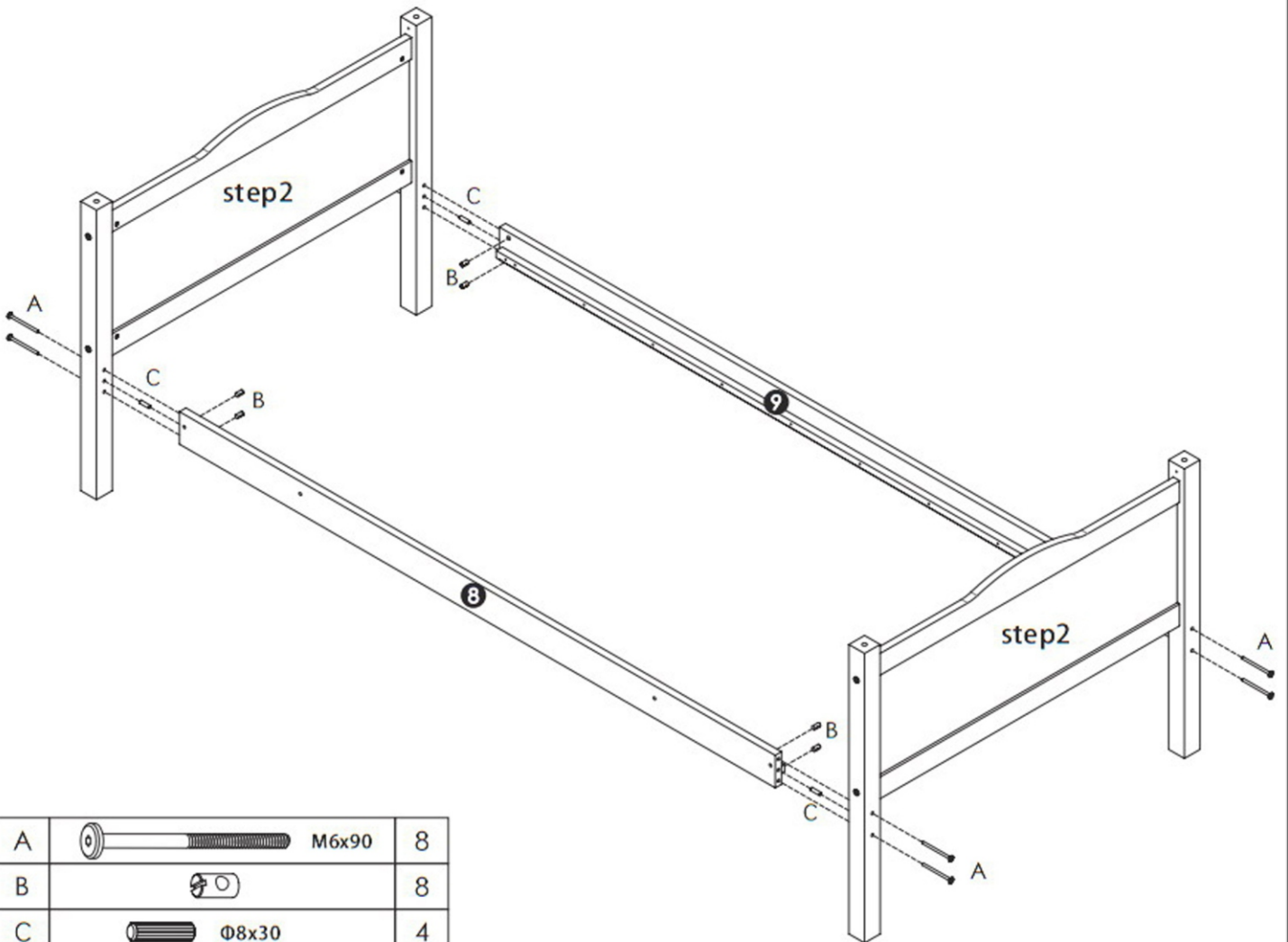

A		M6x90	4
B			4
C		Φ8x30	4



step3



A		M6x90	8
B			8
C		Φ8x30	4

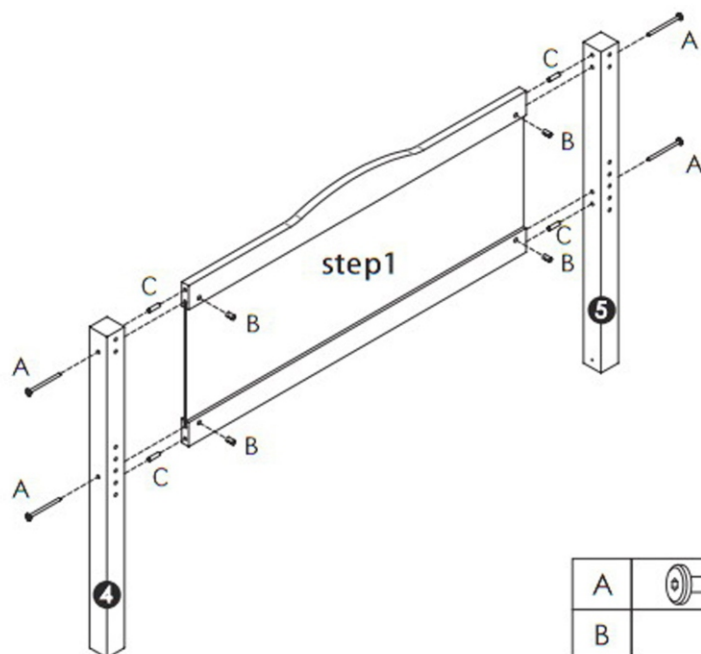

step4 (x2)



A		M6x90	4
B			4
C		Φ8x30	4

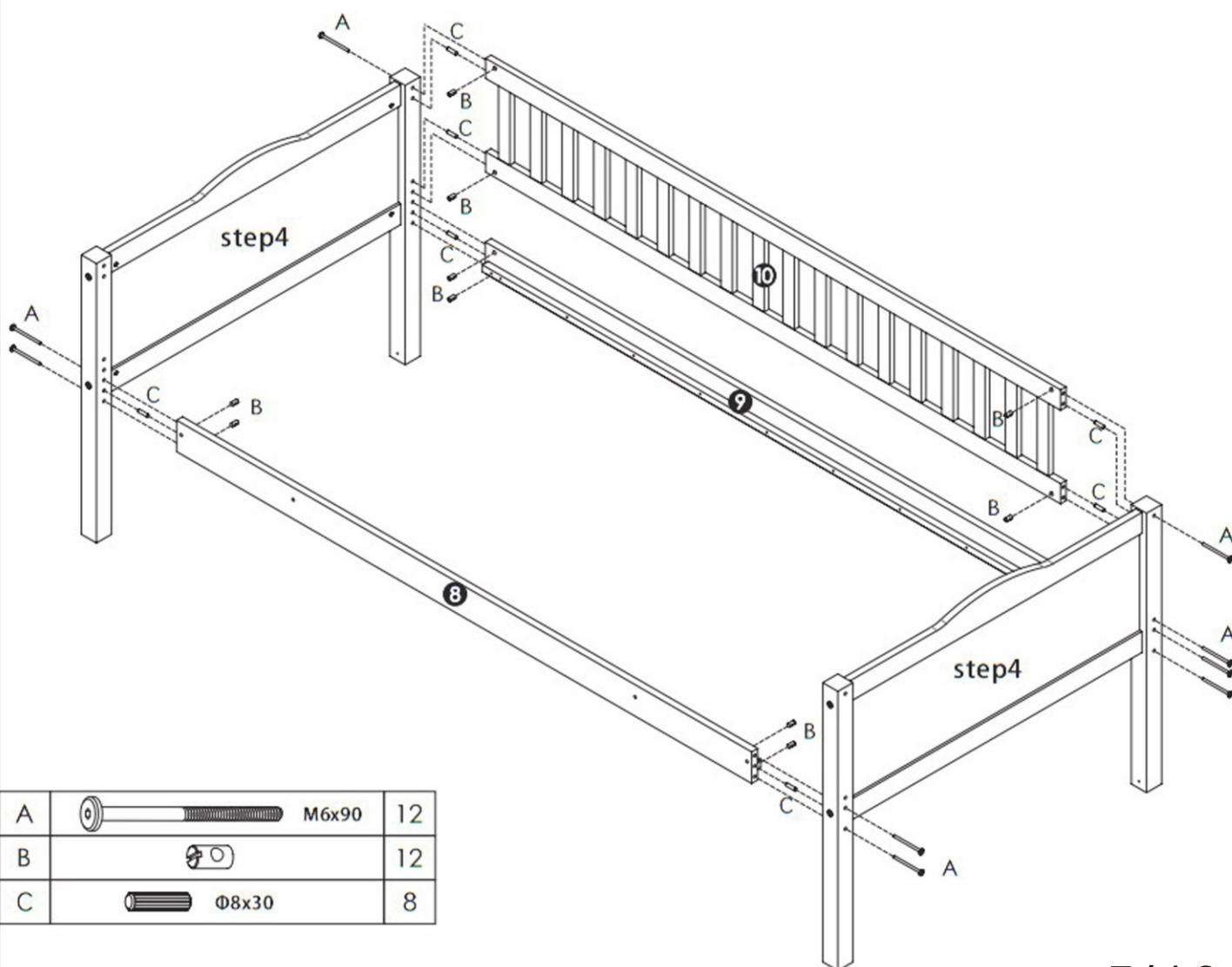

step5

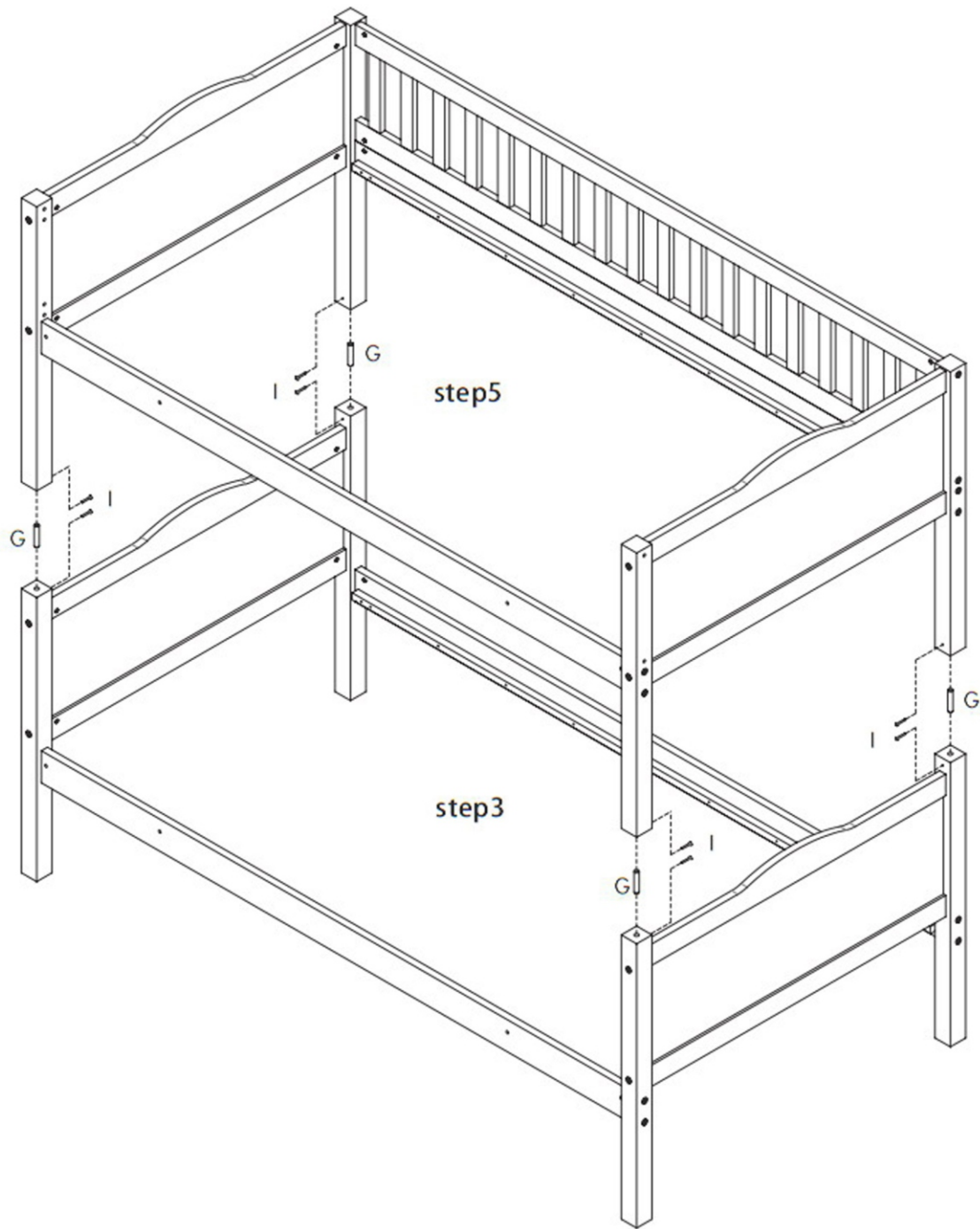

A		M6x90	12
B			12
C		Φ8x30	8

step6





G		Φ12x60	4
I		Φ4x30	8

step7

OPTION A



A		M6x90	2
B			2
C		Ø8x30	2





OPTION B

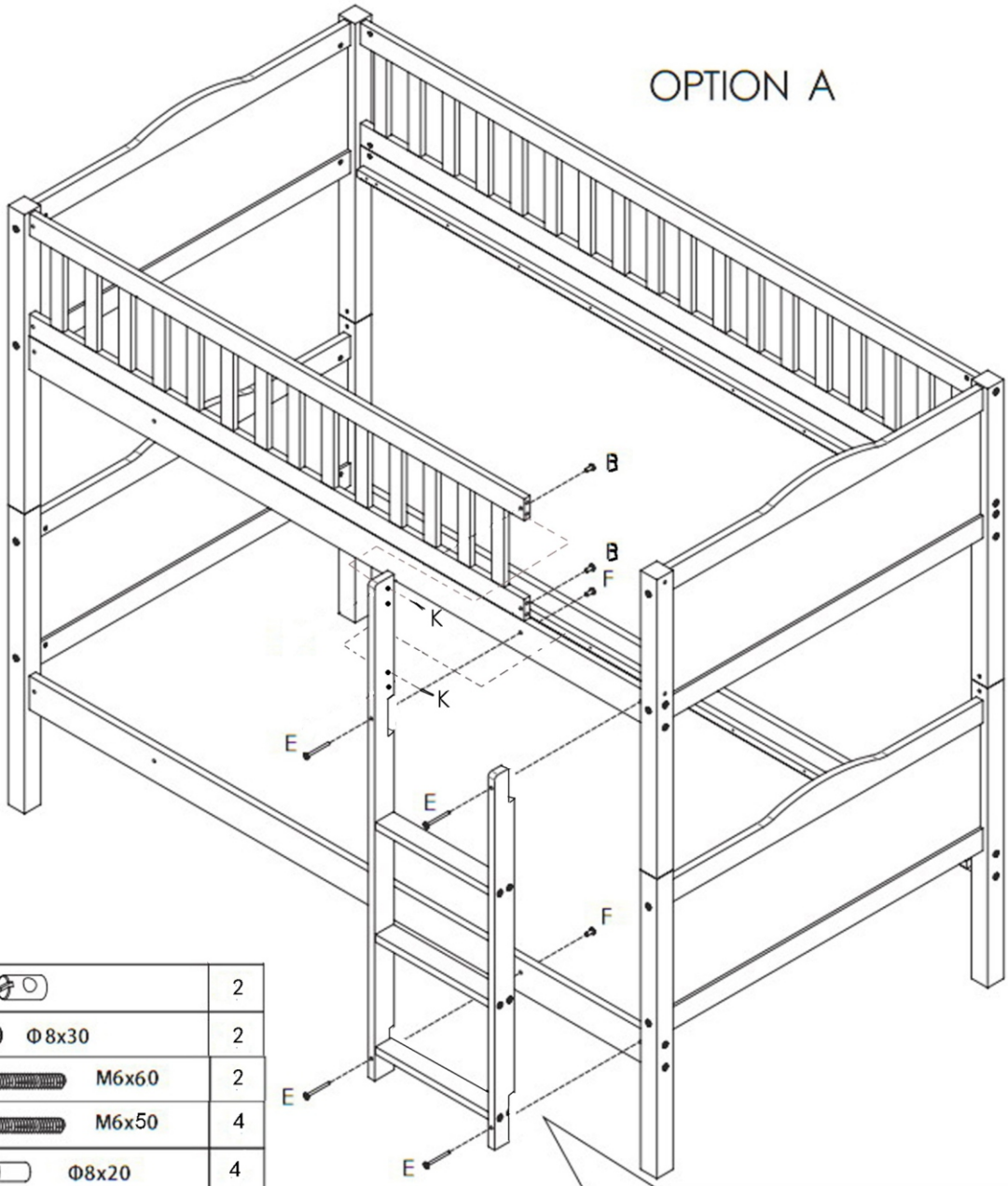

step8

OPTION A



B		2
C	 $\Phi 8 \times 30$	2
K	 $M6 \times 60$	2
E	 $M6 \times 50$	4
F	 $\Phi 8 \times 20$	4

OPTION B

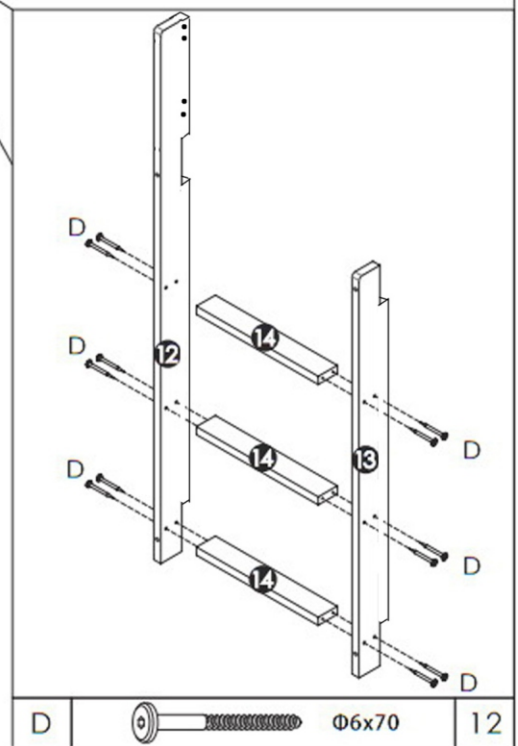
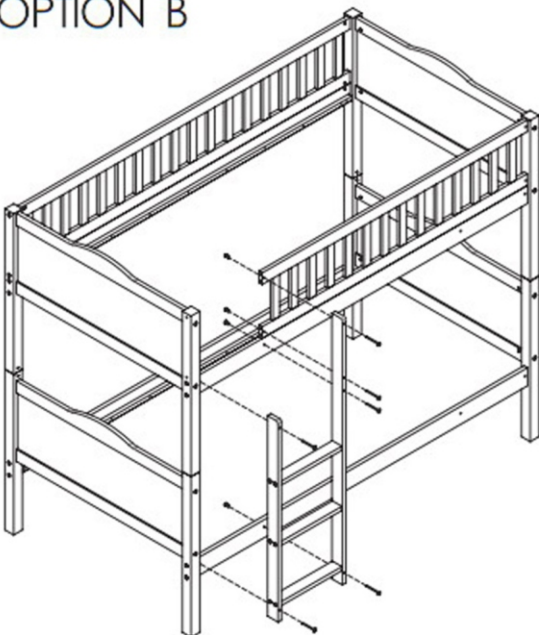

step9

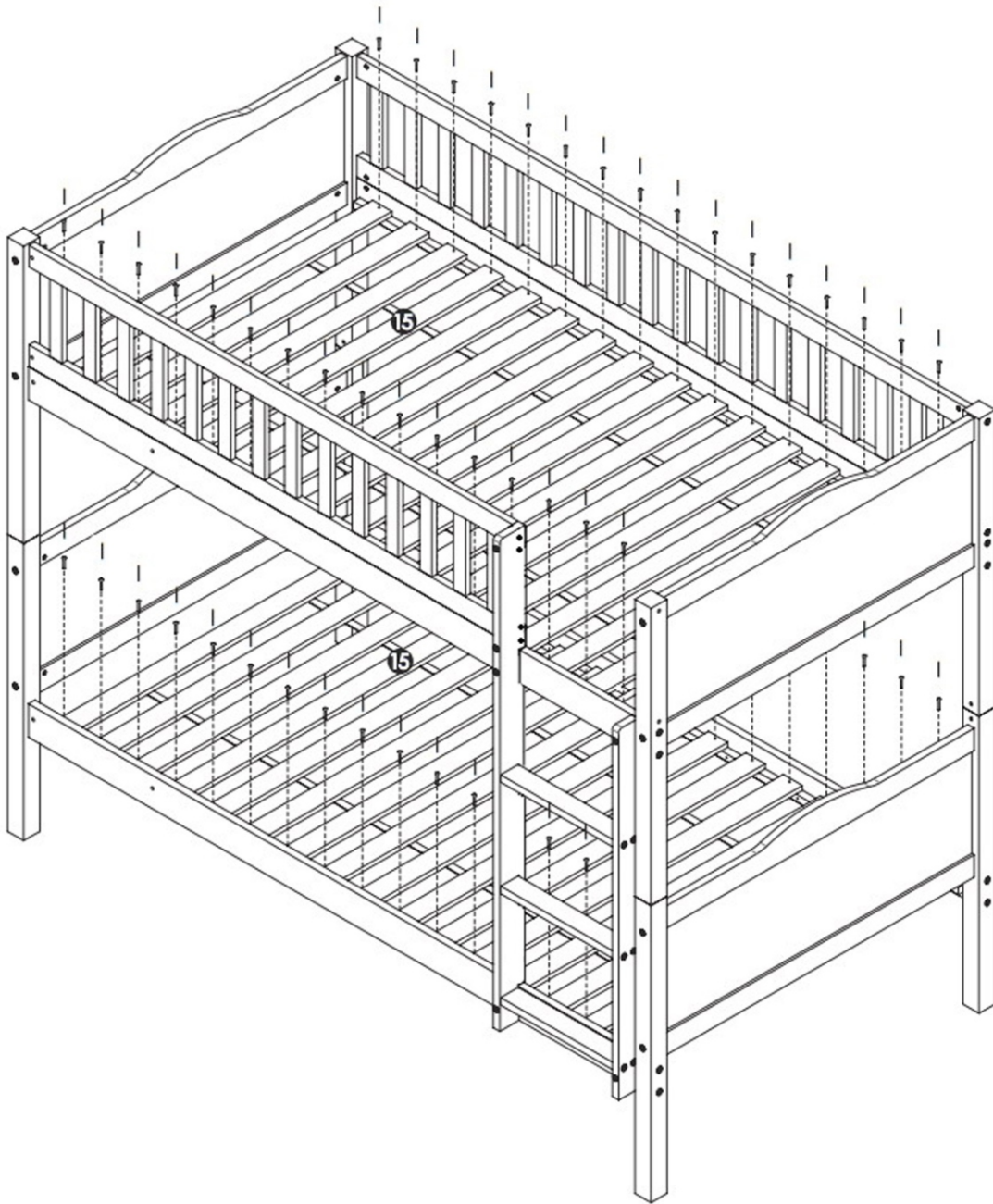

step 10



J	0	14
---	---	----